



STENNER

Peristaltic Metering Pumps
Since 1957

BDF Series

INSTALLATION AND
MAINTENANCE MANUAL

Table of Contents

Warranty and Service Policy	3
Safety Information	4-5
Pump Identification	6-7
Outputs	8
Materials of Construction	9
Accessory Checklist	10
Programming Instructions	11-17
Installation	18-24
Troubleshooting	25-27
Separating and Reconnecting Subassemblies	28
Tube Replacement	29-33
Cleaning the Point of Injection	34-36
Motor – exploded view and parts	37
Pump Head – exploded view and parts	38-40
Pump Tubes	41
Check Valves	42
For Your Records	43

Warranty and Service Policy

Limited Warranty

Stenner Pump Company will for a period of one (1) year from the date of purchase (proof of purchase required) repair or replace – at our option – all defective parts. Stenner is not responsible for any removal or installation costs. Pump tube assemblies and rubber components are considered perishable and are not covered in this warranty. Pump tube will be replaced each time a pump is in for service, unless otherwise specified. The cost of the pump tube replacement will be the responsibility of the customer. Stenner will incur shipping costs for warranty products shipped from our factory in Jacksonville, Florida. Any tampering with major components, chemical damage, faulty wiring, weather conditions, water damage, power surges, or products not used with reasonable care and maintained in accordance with the instructions will void the warranty. Stenner limits its liability solely to the cost of the original product. We make no other warranty expressed or implied.

Returns

Stenner offers a 30-day return policy on factory direct purchases. Except as otherwise provided, no merchandise will be accepted for return after 30 days from purchase. To return merchandise at any time, call Stenner at 800.683.2378 for a Return Merchandise Authorization (RMA) number. A 15% re-stocking fee will be applied. Include a copy of your invoice or packing slip with your return.

Damaged or Lost Shipments

UPS and prepaid truck shipments: Check your order immediately upon arrival. All damage must be noted on the delivery receipt. Call Stenner Customer Service at 800.683.2378 for all shortages and damages within seven (7) days of receipt.

Service & Repairs

Before returning a pump for warranty or repair, remove chemical from pump tube by running water through the tube, and then run the pump dry. Following expiration of the warranty period, Stenner Pump Company will clean and overhaul any Stenner metering pump for a minimum labor charge plus necessary replacement parts and shipping. All metering pumps received for overhaul will be restored to their original condition. The customer will be charged for missing parts unless specific instructions are given. To return merchandise for repair, call Stenner at 800.683.2378 or 904.641.1666 for a Return Merchandise Authorization (RMA) number.

Disclaimer

The information contained in this manual is not intended for specific application purposes. Stenner Pump Company reserves the right to make changes to prices, products, and specifications at any time without prior notice.

Safety Information

 **WARNING** Warns about hazards that CAN cause death, serious personal injury, or property damage if ignored.

 **ELECTRIC SHOCK HAZARD**

 **WARNING** **ELECTRIC SHOCK HAZARD:**
Pump supplied with grounding power cord and attached plug. To reduce risk of electrical shock, connect only to a properly grounded, grounding type receptacle. Install only on a circuit protected by a ground-fault circuit Interrupter (GFCI).

 **AVERTISSEMENT** **RISQUE DE CHOC ELECTRIQUE:**
Cette pompe est équipée d'une fiche de mise à terre. Pour réduire le risque de choc électrique, s'assurer que la fiche est bien raccordée à une prise de courant avec une connexion de mise à terre. Installer seulement sur un circuit protéger par un interrupteur protéger par une mise à la terre.

 **DO NOT** alter the power cord or plug end.

 **DO NOT** use receptacle adapters.

 **DO NOT** use pump with a damaged or altered power cord or plug. Contact the factory or an authorized service facility for repair.

 **WARNING** **RISK OF CHEMICAL EXPOSURE:**
Potential for chemical burns, fire, explosion, personal injury, or property damage. To reduce risk of exposure, the use of proper personal protective equipment is mandatory.

 **WARNING** **RISK OF FIRE HAZARD:**
DO NOT install or operate on any flammable surface.

 **WARNING** **HAZARDOUS VOLTAGE:**
DISCONNECT power cord before removing motor cover for service. **Electrical service by trained personnel only.**

 **WARNING** **EXPLOSION HAZARD:**
This pump is not explosion proof. **DO NOT** install or operate in an explosive environment.

 Pump is equipped with a safety interlock switch. This switch ensures that all supply voltage is disconnected from the timer board in the event the cover is removed prior to unplugging the power cord. **DO NOT** tamper with or alter this switch in any way. Failure to follow this warning will void the warranty and can lead to personal injury or property damage.

 **Electrical service by trained personnel only.** Pump is not user serviceable in regards to electrical components. Contact the factory or an authorized service facility for repair.

Safety Information continued

 **NOTICE:** Indicates special instructions or general mandatory action.

 **NOTICE:** This metering pump is portable and designed to be removable from the plumbing system without damage to the connections.

 **NOTICE:** This metering pump and its components have been tested for use with the following chemicals: Sodium Hypochlorite (10-15%), Muriatic Acid (20-22% Baume, 31.5% Hcl), and Soda Ash.

 **NOTE:** Cette a pompe de dosage et ses composants ont été testés pour utilisation avec les produits chimiques suivants; Hypochlorite de Sodium (solution de 10-15%); Acide Muriatique (20-22% Baume, 31.5% Hcl); Cendre de Soude.

 **This is the safety alert symbol. When displayed in this manual or on the equipment, look for one of the following signal words alerting you to the potential for personal injury or property damage.**

 Electrical installation should adhere to all national and local codes. Consult a licensed professional for assistance with proper electrical installation.

 **PUMP INTENDED FOR INDOOR USE.**

 Cette pompe est prévue pour utilisation à l'intérieur.

Pump Identification

Identify your pump using the label on the box or the pump.

Box Label

 STENNER	STENNER PUMP COMPANY Jacksonville, FL Phone: (904)641-1666 MADE IN U.S.A.
MODEL/MODELO	25BDF5
SERIAL NO./NO. DE SERIAL	02050503955
VOLTAGE/VOLTAJE	120
MAX GPD/MAX LPD	4/15.1
PSI/BAR	25/1.7
SUCTION/DISCHARGE TUBING TUBO DE SUCCION/DESCARGA	1/4" White 1/4" Blanco
ITEM NO./NO. DE PARTE	BDFHL5F1SQAA
www.stenner.com	

Pump Identification continued

Data Label

	STENNER PUMP COMPANY 3174 DeSalvo Road Jacksonville, FL 32246 USA Phone: 904.641.1666 www.stenner.com
25BDF5 MODEL # No. de modelo	
BDFHL5F1SQAA ITEM # No. de parte	
25 psi / 1.7 bar	120V 60Hz
1.2 amp	4 gpd / 15.1 lpd
02050503955 SERIAL # No. de serial	MADE IN USA
FL	

Warning Label

⚠ [WARNING] To reduce risk of electric shock, connect only to a properly grounded grounding-type receptacle.

⚠ [PELIGRO] Para reducir el riesgo de descarga eléctrica, conéctelo a un receptáculo eléctrico con conexión a tierra adecuado.

⚠ [CAUTION] To reduce risk of electric shock, pull plug before servicing this pump.

⚠ [CUIDADO] Para reducir el riesgo de descarga eléctrica, desenchufe el dosificador antes de realizar reparaciones.

⚠ [WARNING] To reduce risk of electric shock, install only on a circuit protected by a ground-fault circuit Interrupter (GFCI).

⚠ [PELIGRO] Para reducir el riesgo de descarga eléctrica, instale el dosificador en un circuito protegido por un interruptor diferencial.

See installation instructions for overdosing protection.
Lea las instrucciones de instalación para evitar sobredosis de químicos.

Thermally Protected Motor for Indoor Use.
Motor termal protegido para el uso interior.

Suitable for Indoor and Outdoor Use.
Adecuado para el uso interior y exterior.

Nonsubmersible Pump.
Dosificador no submergible.

METERING PUMP

METERING PUMP
LR79585



NOTE: Agency listings vary by model.

Outputs

Model	Pressure	Timer	Pump Tube	Pump Output per Dose Hour								
				Min. to Max. Ounces	Min. to Max. Millimeters	Bank of Dose Switches						
						1	2	3	4	5	6	
25BDF1HP*	100 psi (6.9 bar)	24-hour	#1	0.06 to 1.3	2 to 39	Ounces	0.06	0.12	0.18	0.24	0.3	0.36
25BDF1	25 psi (1.7 bar)	24-hour	#1			Milliliters	2	4	6	8	10	12
25BDF1HP-7*	100 psi (6.9 bar)	7-day	#1									
25BDF1-7	25 psi (1.7 bar)	7-day	#1									
25BDF2HP*	100 psi (6.9 bar)	24-hour	#2	0.21 to 4.5	6 to 134	Ounces	0.21	0.42	0.63	0.84	1.05	1.26
25BDF2	25 psi (1.7 bar)	24-hour	#2			Milliliters	6	12	18	24	30	36
25BDF2HP-7*	100 psi (6.9 bar)	7-day	#2									
25BDF2-7	25 psi (1.7 bar)	7-day	#2									
25BDF3	25 psi (1.7 bar)	24-hour	#3	0.48 to 10	14 to 302	Ounces	0.48	0.96	1.44	1.92	2.40	2.88
25BDF3-7	25 psi (1.7 bar)	7-day	#3			Milliliters	14	28	42	56	70	84
25BDF4	25 psi (1.7 bar)r	24-hour	#4									
25BDF4-7	25 psi (1.7 bar)	7-day	#4	0.71 to 15	21 to 449	Ounces	0.71	1.42	2.13	2.84	3.55	4.26
25BDF4-7	25 psi (1.7 bar)	7-day	#4	Milliliters	21	42	63	96	105	126		
25BDF5	25 psi (1.7 bar)	24-hour	#5	1 to 21	30 to 625	Ounces	1	2	3	4	5	6
25BDF5-7	25 psi (1.7 bar)	7-day	#5			Milliliters	30	60	90	120	150	180

*Pump supplied with injection check valve for 26-100 psi (1.7-6.9 bar) applications

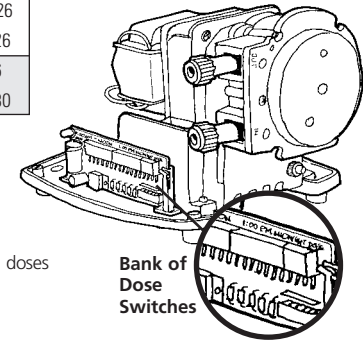
- Within the Bank of Dose Switches each number represents the number of doses
- 1 dose represents approximately 25 seconds of run time
- Any dip switch in the UP position represents a programmed dose amount
- The sum of the dip switches in the UP position equals the dose amount for example, switches 2,4 and 5 in the UP position will give 11 doses
- All dip switches in the UP position will pump the maximum dosage amount for the pump (21 doses)



NOTICE: The information within this chart is solely intended for use as a guide. The output data is an approximation based on pumping water under a controlled testing environment. Many variables can affect the output of the pump. Stenner Pump Company recommends that all metering pumps undergo field calibration by means of analytical testing to confirm their outputs.

Materials of Construction

- All Housings* Lexan® Polycarbonate Plastic
- Peristaltic Tube** Santoprene® FDA Approved
Check Valve Duckbill
- Peristaltic Tube† Tygothane® FDA Approved
Check Valve Duckbill** Pellathane®
- Suction/Discharge Tubing LDPE Polyethylene-NSF/FDA Approved
Ferrules
- Tube Fittings Type 1 Rigid PVC-NSF Listed
Connecting Nuts
Check Valve Fittings
Weighted Suction Line Strainer
- All Fasteners Stainless Steel

*Lexan® is a registered trademark of General Electric. Consult General Electric for chemical resistance of Lexan®.

**Santoprene® is a registered trademark of Advanced Elastomer System.

†Tygothane® is a registered trademark of Saint-Gobain Performance Plastics.

**Pellathane® is a registered trademark of The Dow Company.

Accessory Checklist – pre-installation

25 psi unit includes:

- 3 Connecting Nuts 1/4"
- 3 Ferrules
- 1 Injection Fitting
- 1 Weighted Suction Line Strainer 1/4"
- 1 20' Roll of Suction & Discharge Tubing 1/4" White
- 1 Installation and Maintenance Manual

100 psi unit includes:

- 3 Connecting Nuts 1/4"
- 3 Ferrules
- 1 Injection Check Valve
- 1 Weighted Suction Line Strainer 1/4"
- 1 20' Roll of Suction & Discharge Tubing 1/4" White
- 1 Installation and Maintenance Manual

Programming Instructions

KEY

On: Dip switch in the **UP** position

Off: Dip switch in the **DOWN** position

Dose Hour: The programmed time when the dose amount is injected.
Minimum is 1 hour per day and maximum is 24 hours per day

1 Dose: Minimum volume of liquid injected (#1 dip switch in the UP position)

21 Doses: Maximum dose amount

Dose Amount: The volume of liquid to be injected per dose hour. The dose amount is the sum of the dip switches in the UP position

Example:

- The minimum dose amount is 1 dose and is the #1 dip switch in the UP position.
- 3 doses are the #3 dip switch in the UP position or #1 & #2 dip switches in the UP position.
- The maximum dose amount is 21 doses and is all of the switches in the UP position. Dip switch numbers $1+2+3+4+5+6 = 21$ doses.

More on next page...

SUMMARY OF STEPS

- I. Battery
- IA. 7-day timer only, select days of the week
- II. Set time of day
- III. Select dose amount
- IV. Program hours for dose event
- V. Prime

Programming Instructions continued

I. BATTERY

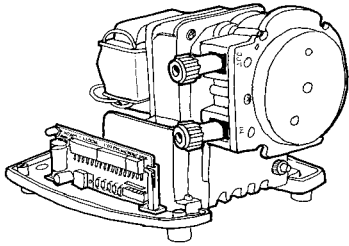

WARNING

ELECTRIC SHOCK HAZARD:

DO NOT plug power cord into receptacle; perform programming without AC power.

1. Remove the four screws to remove pump cover and confirm that all dip switches on the circuit board are in the down position.
2. Connect the supplied 9V battery. This will illuminate the green LED light. Replace battery if light does not illuminate.

NOTE: The battery only retains the time of day and will not run the pump if AC power is lost.

Programming Instructions continued

IA. 7-DAY TIMER ONLY, SELECT DAYS OF THE WEEK

NOTE: Skip this step if using 24-hour timer and proceed to step II.

On the 7-day timer board, dip switches 1-7 in the first bank of switches represent the days of the week. Switch 1 represents the day that the timer is activated.

For example, if the pump is programmed on Wednesday, then the third switch would represent Friday.

1. Press and hold the prime switch (located beneath the pump head) to illuminate the green LED light to flashing indicating the "day of the week" mode is active.
2. Lift the dip switches to represent the days of the week that the pump is to dose.
3. Record the programmed day settings by pressing the red prime switch once again. The green LED light will turn off.

The 7-day timer is now set.

4. Set all switches to the down position. The green LED light will illuminate.

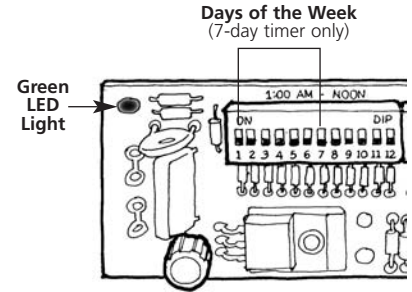

More on next page...

Programming Instructions continued

II. SET TIME OF DAY

From left to right, the first bank of switches represents 1 a.m. to noon. The second bank represents 1 p.m. to midnight.

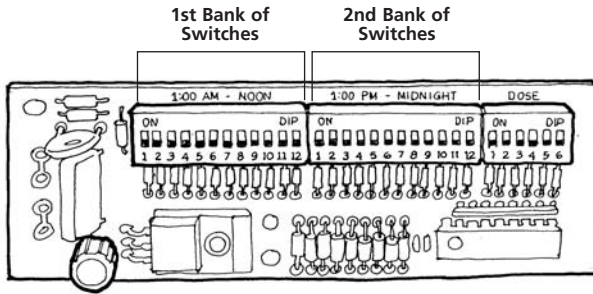

1. Set the time of day by lifting the dip switch that is closest to the current time of day. The green LED will turn off.

The time of day is now set.

NOTE: To erase the setting, push all dip switches down and return to the battery instructions.

More on next page...

Programming Instructions continued

III. SELECT DOSE AMOUNT

From left to right, use the third bank of switches 1-6.

1. Refer to the output chart on page 8.

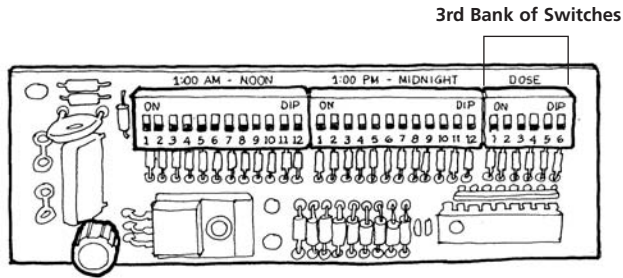

2. Set the dose amount per hour by lifting the corresponding dose switches.
3. Dose amounts are cumulative.
For example, switches 2, 4 & 6 in the UP position will feed 12 doses ($2+4+6=12$).

More on next page...

Programming Instructions continued

IV. PROGRAM HOURS FOR DOSE EVENT

1. Leave dose switches (third bank: 1-6) in their programmed position.
2. Keep the time of day switch in the UP position (either 1st or 2nd bank of switches), lift the dip switches to correspond with the hour(s) of the day that the pump will feed solution.
3. After setting the dip switches in the DOWN position, push the time of day switch down if solution is not to be pumped at that hour.

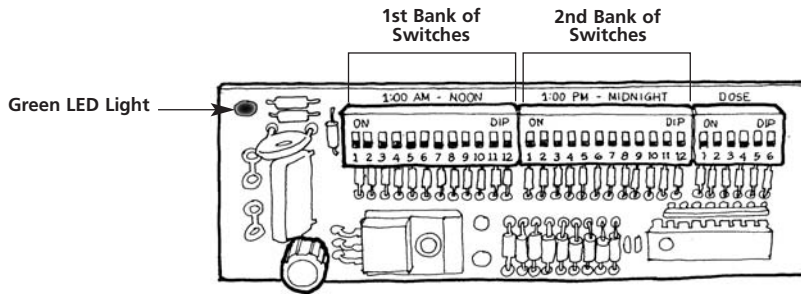

- ! NOTICE:** If all 24 hourly switches are set in the DOWN position at any time, the board will lose its programmed time of day. If this occurs, return to the Step I.
4. Install the cover by securing the four cover screws and plug the unit into a properly grounded receptacle.

More on next page...

Programming Instructions continued

V. PRIME

1. Press the red prime button to prime the pump. The pump will automatically shut off after 60 seconds. To discontinue pump operation during the 60-second prime cycle, press the prime button again.
2. Cycle as necessary to pump solution to the point of injection.

The BDF is now ready for operation.

! NOTICE: To retain this program schedule, the 9V battery is a back-up in case AC power is lost.

7-Day Model

If AC power is lost and the 9V battery fails, the pump will default to OFF once the power is restored. To reprogram the settings, unplug the pump and replace the battery.

24-Hour Model

If AC power is lost and the 9V battery fails, the pump will default to 12 pm when power is restored and the pump will resume its dose schedule and dose amounts. If the dose schedule needs to correspond with the actual time of day, unplug the pump, replace the battery, and reprogram all settings.

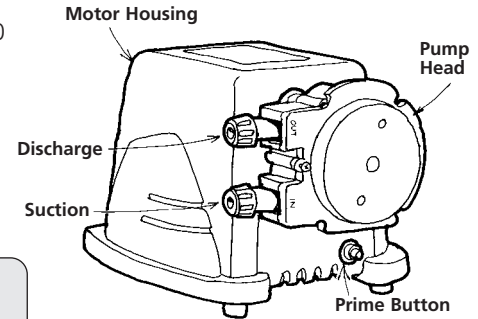

Installation – additional safety instructions



NOTICE: Indicates special instructions or general mandatory action.



Read all safety hazards before installing or servicing the pump. The pump is designed for installation and service by properly trained personnel.



Use all required personal protective equipment when working on or near a chemical metering pump.



Install the pump so that it is in compliance with all national and local plumbing and electrical codes.



Use the proper product to treat potable water systems, use only chemicals listed or approved for use.



Install the pump to work in conjunction with well pump or system controls.

Installation continued – mount pump

MOUNT PUMP

- ❗ Select a dry location (to avoid water intrusion and pump damage) above the solution tank.
 - ❗ To prevent pump damage in the event of a pump tube leak, never mount the pump vertically with the pump head up.
 - ❗ To avoid chemical damage from fumes, DO NOT mount pump directly over an open solution tank. Keep tank covered.
 - ❗ Avoid flooded suction or pump mounted lower than the solution container. Draw solution from the top of the tank. Pump can run dry without damage. If pump is installed with a flooded suction, a shut-off valve or other device must be provided to stop flow to pump during service.
 - ❗ DO NOT allow water intrusion into the motor or corrosion and damage will occur.
 - ❗ To prevent motor damage, verify with a volt meter that the receptacle voltage corresponds with the pump voltage.
- ❗ **NOTICE: DO NOT** plug metering pump into power source unless BDF has been programmed.

More on next page...

Installation Diagram

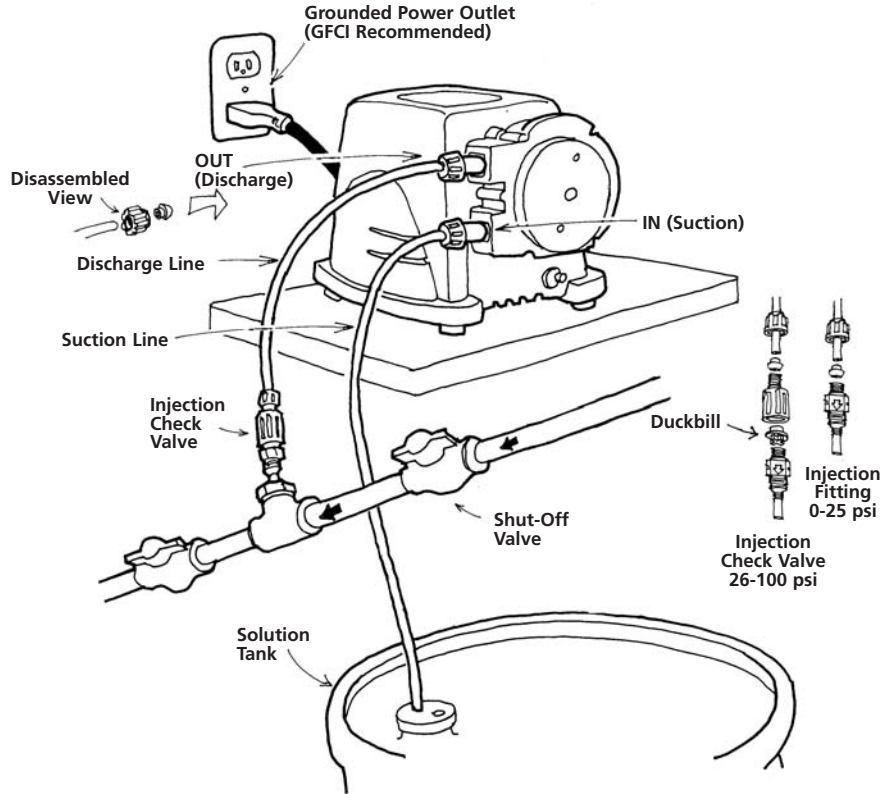

Installation continued – suction/discharge lines

INSTALL SUCTION/DISCHARGE LINE TO PUMP HEAD

1. Uncoil the suction/discharge line. Use outside of solution tank as a guide to cut proper length of suction line ensuring it will be 2-3" above the bottom of solution tank.

! Allow sufficient slack to avoid kinks and stress cracks. Always make a clean square cut to assure that the suction line is burr free. Normal maintenance requires trimming.

! Suction lines that extend to the bottom of the tank can result in debris pickup leading to clogged injectors and possible tube failure.

2. Make connections by sliding the line(s) through connecting nut and ferrule and finger tighten to the corresponding tube fittings. Suction side tube connection is indicated by "IN" on the tube housing cover.

3. Finger tighten nut to the threaded tube fitting while holding the tube fitting.

! Over tightening the ferrule and nut with a wrench may result in damaged fittings, crushed ferrules, and air pick up.

! DO NOT use thread sealant tape on pump tube connections or tools to tighten connections.

DO NOT use thread sealant tape on pump tube threads.

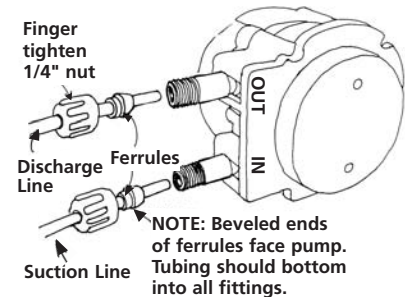
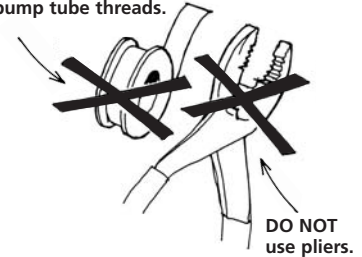

More on next page...

Installation continued – suction line

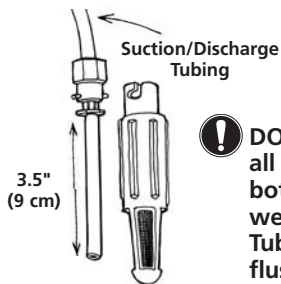
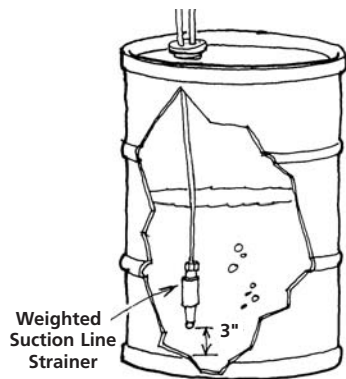

! DO NOT slide tubing all the way to the bottom of the weighted strainer. Tubing could become flush with the nose of the strainer and the pump may not prime due to blockage.

INSTALL SUCTION WEIGHT

1. Drill a hole into the bung cap or solution tank lid. Slide the tubing through and secure the weighted strainer to the line.
2. To attach the strainer, slide approximately 3 1/2" of tubing through the collet and lock into place on strainer body. Pull tubing to make sure it is secure.
3. Suspend slightly above tank bottom to reduce the chance of sediment pickup.

- !** DO NOT mix chemicals in the solution container. Follow recommended mixing procedures according to the manufacturer.
- !** DO NOT operate pump unless chemical is completely in solution. Turn pump off when replenishing solution.

Installation continued – point of injection

INSTALL INJECTION POINT

1. Make a secure finger tight connection on the discharge fitting of the pump head as instructed in Install Suction Line instructions.

! **DO NOT use thread sealant tape on pump tube connections or tools to tighten connections.**

! **WARNING** **HAZARDOUS PRESSURE:** Shut off water or circulation system and bleed off any system pressure.

! **Locate a point of injection beyond all pumps and filters or as determined by the application.**

2. A 1/4" or 1/2" Female NPT (FNPT) connection is required for installing the injection fitting. If there is no FNPT fitting available, provide one by either tapping the pipe or installing FNPT pipe tee fitting.
3. Wrap the Male NPT (MNPT) end of injection fitting with 2 or 3 turns of threading tape. If necessary, trim the injection fitting quill as required to inject product directly into flow of water.

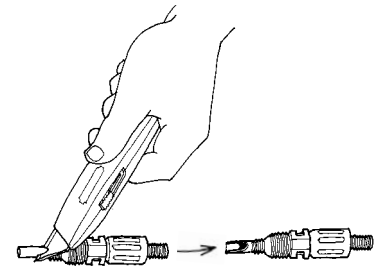
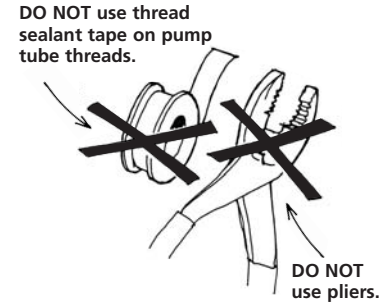

More on next page...

Trim Injection Fitting

Installation continued – point of injection

Typical Point of Injection

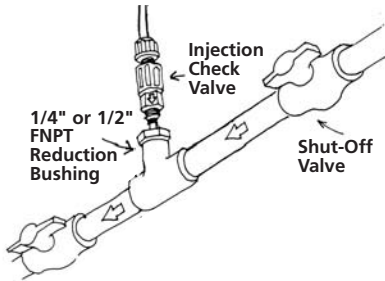

WARNING

HAZARDOUS PRESSURE:
Shut off water or circulation system
and bleed off any system pressure.

4. Hand tighten the injection fitting into the FNPT fitting.

0-25 psi Models (includes injection fitting)

- a. Install connecting nut and ferrule to the pump discharge tubing. Insert discharge tubing into injection fitting until it reaches base of fitting.
- b. Finger tighten connecting nut to fitting.

26-100 psi Models (includes injection check valve)

- a. Prior to connection, test injection check valve and NPT threads for leaks by pressurizing system. If necessary, tighten an additional 1/4 turn.
- b. Install connecting nut and ferrule to the pump discharge tubing. Insert discharge tubing into check valve body until it reaches base of body.
- c. Finger tighten connecting nut to fitting.

5. Turn pump on and re-pressurize system. Observe chemical flow as actuated by system and check all connections for leaks.
6. After suitable amount of dosing time, perform tests for required solution levels



The injection point and fitting require periodic maintenance to clean any deposits or buildup. To allow quick access to the point of injection, Stenner recommends the installation of shut-off valves.

Troubleshooting – motor

PROBLEM	POSSIBLE CAUSE	SOLUTION
Motor	 WARNING HAZARDOUS VOLTAGE: DISCONNECT power cord before removing motor cover for service. Electrical service should be by trained personnel only.	
LED doesn't illuminate.	Battery is dead. Dip switches are up (ON).	Replace 9V battery. DO NOT hook up battery until at the job site. Dip switches should be down (OFF) before connecting battery. (NOTE: If all dip switches are down and the battery is good, possible board problem. Consult factory.)
Pump not dosing the proper schedule.	No power at the receptacle. Long-term power outage/low 9V battery caused pump to lose program.	Confirm power is restored, check battery, and if necessary, replace and reprogram. Replace battery and re-program. If the battery is disconnected from the pump, the programs will be lost.
Pump rollers not turning when prime button is pressed.	Motor is bad or interlock switch not working because motor cover is not secured.	Replace motor or secure motor cover to base.



NOTICE: To retain this program schedule, the 9V battery is a back-up in case AC power is lost.

7-Day Model

If AC power is lost and the 9V battery fails, the pump will default to OFF once the power is restored. To reprogram the settings, unplug the pump and replace the battery.

24-Hour Model

If AC power is lost and the 9V battery fails, the pump will default to 12 pm when power is restored and the pump will resume its dose schedule and dose amounts. If the dose schedule needs to correspond with the actual time of day, unplug the pump, replace the battery, and reprogram all settings.

Troubleshooting continued – pump head

PROBLEM	POSSIBLE CAUSE	SOLUTION
Components cracking	Chemical attack	Check chemical compatibility
Pump head leaking	Pump tube rupture	Replace pump tube, ferrules; center tube
No pump output, pump head rotates	Depleted solution tank Pump suction line weight is above solution Leak in the suction line Ferrules installed incorrectly, missing or damaged Injection point is clogged Clogged suction/discharge tubing and/or injection check valve Life of pump tube exhausted Suction tubing is flush with the nose of the weighted strainer	Replenish solution Replenish solution Inspect or replace suction line Replace ferrules Inspect and clean injection point Clean and/or replace as needed Replace pump tube, ferrules; center tube Pull suction tubing approximately 1" from bottom of strainer Cut bottom of suction tubing at an angle
Low pump output, pump head rotates	Life of pump tube exhausted Rollers worn or broken Injection point is restricted Incorrect tube size High system back pressure	Replace pump tube, ferrules; center tube Replace roller assembly Inspect and clean injection point Replace tube with correct size Verify system pressure against tube psi, replace tube if needed
No pump output;pump head doesn't rotate	Stripped roller assembly Motor problem	Replace roller assembly Refer to motor section
Pump output high	Incorrect tube size or setting Roller assembly broken	Replace tube with correct size or adjust settings. Replace roller assembly

Troubleshooting continued – pump tube

PROBLEM	POSSIBLE CAUSE	SOLUTION
<p>! NOTICE: A leaking pump tube damages the metering pump. Inspect pump frequently for leakage and wear. Refer to Tube Replacement section for additional safety precautions and instructions.</p>		
<p>Tube leaking</p>	<p>Pump tube ruptured Calcium or mineral deposits Excessive back pressure Tube is twisted Tube not centered</p>	<p>Replace pump tube, ferrules; center tube Clean injection fitting, replace pump tube, ferrules; center tube Verify system pressure against tube psi, replace tube if needed Replace pump tube, ferrules; center tube Replace pump tube, ferrules; center tube</p>
<p>Tube life is shortened</p>	<p>Chemical attack Mineral deposits at injection point Sediment blockage at check valve Degraded check valve duckbill Duckbill in wrong orientation Tube manually stretched or pinched during replacement Seized rollers caused abrasion on tube Exposure to heat or sun</p>	<p>Check chemical compatibility Remove deposits, replace pump tube, ferrules; center tube Maintain suction line 2-3" above bottom of tank Replace duckbill at every tube change Reverse duckbill orientation Follow tube replacement instructions and allow roller assembly to stretch tube into place Clean roller assembly or replace Do not store tubes in high temperatures or in direct sunlight</p>
<p>Tube connection is leaking</p>	<p>Missing ferrule on 1/4" line Crushed ferrule Ferrule in wrong orientation</p>	<p>Replace ferrule Replace ferrule Reverse orientation of ferrule</p>

Separating and Reconnecting Subassemblies

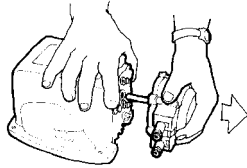

Separating

1. Turn off the pump and unplug the power cord.
2. Hold the motor section and turn the pump head clockwise, until it stops.
3. Pull the pump head straight out and off.

NOTE: Older pumps or pumps that have had a tube rupture may require the use of a flat blade screwdriver to assist in pump head removal. Turn pump head counterclockwise until it stops. Insert the screwdriver behind the pump head and carefully pry the pump head off the motor shaft while pulling.

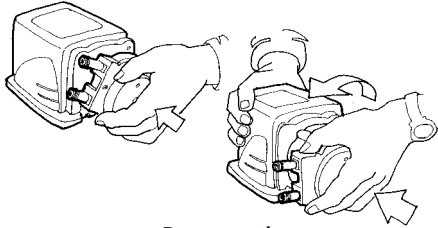





Reconnecting

1. Hold the pump motor section and insert the motor shaft into the pump head making sure the flat of the motor shaft aligns with the the corresponding flat of roller assembly.
2. Rotate the pump head until the locking rivets on the front of the pump motor align with the corresponding mounting locations of the pump head.
3. Push the head onto the motor shaft until it bottoms.
4. Turn counterclockwise to engage mounting rivets.

Reconnecting Pump Head to Motor

Tube Replacement – safety information



WARNING RISK OF CHEMICAL EXPOSURE:

-  To reduce risk of exposure, check the pump tube regularly for leakage. At the first sign of leakage, replace the pump tube.
-  To reduce risk of exposure, the use of proper personal protective equipment is mandatory when working on or near chemical metering pumps.
-  To reduce risk of exposure, and also prior to service, shipping, or storage, pump generous amounts of water or a compatible buffer solution to remove chemical from pump.
-  Consult chemical manufacturer and MSDS sheet for additional information and precautions for the chemical in use.
-  Personnel should be skilled and trained in the proper safety and handling of the chemicals in use.





CAUTION PINCH POINT HAZARD:

-  Use extreme caution when replacing pump tube. Be careful of your fingers and **DO NOT** place fingers near rollers.

WARNING HAZARDOUS PRESSURE/ CHEMICAL EXPOSURE:

-  Use caution and bleed off all resident system pressure prior to attempting service or installation.
-  Use caution when disconnecting discharge tubing from pump. Discharge may be under pressure. Tubing may contain chemical.

NOTICE: Indicates special instructions or general mandatory action.

-  **NOTICE: DO NOT** apply grease, oil, or lubricants to the pump tube or housing.
-  **NOTICE:** Prior to pump tube replacement, inspect the entire pump head for cracks or damaged components. Ensure rollers turn freely.
-  **NOTICE:** Rinse off chemical residual and clean all chemical and debris from pump head components prior to tube replacement. Apply Stenner grease to main shaft and tube housing cover bushing during tube replacement.
-  **NOTICE: DO NOT** pull excessively on pump tube. Avoid kinks or damage during tube installation.
-  **NOTICE:** Inspect the suction/discharge tubing, injection point (into pipe), and injection check valve duckbill for blockages after any tube rupture. Clear or replace as required.

Tube Replacement continued – preparation

1. Follow all safety precautions prior to tube replacement.
2. Prior to service, pump water or a compatible buffer solution through the pump and suction/discharge line to remove chemical and avoid contact.
3. Turn pump off.
4. Disconnect the suction and discharge connections from pump head.
5. Plug power cord into constantly energized, properly grounded receptacle for service.

Tube Replacement continued – remove old tube

REMOVE OLD TUBE

1. Turn the metering pump off.
2. Remove and set aside cover and screws.
3. Press the PRIME button to jog the roller assembly until one of the three slots in the roller assembly lines up with the bottom tube fitting (suction side). **Illustration A**
4. Turn pump off.
5. Lift tube fitting out of housing slot and pull it toward center of roller assembly. **Illustration B**
6. Press the PRIME button to jog the roller assembly while guiding the tube, with tension, up and out of housing. **Illustration C**
7. Turn pump off. When the slot in the roller assembly aligns with the "OUT" (discharge) tube fitting, remove and discard pump tube.
8. Remove roller assembly and housing.
9. Use non-citrus all-purpose cleaner to clean chemical residue from pump head housing, roller, and cover.
10. Check housing for cracks. Replace if cracked.
11. Ensure rollers spin freely. **Illustration D**
12. Replace roller assembly if: seized, excessive side play from bore wear, or if rollers are visibly worn.
13. Reinstall clean tube housing.
14. Install roller assembly.

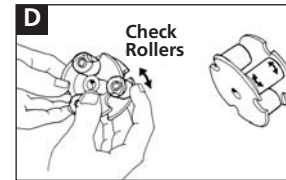
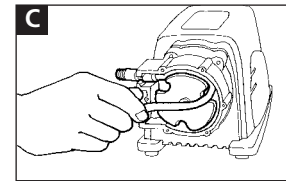
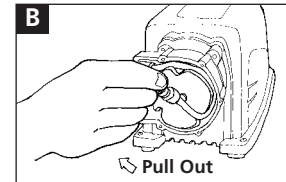
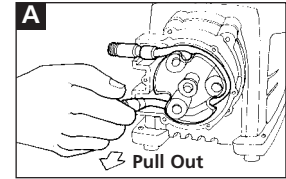

Tube Replacement continued – install new tube

IMPORTANT! DO NOT lubricate pump tube or roller assembly.

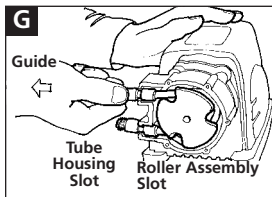
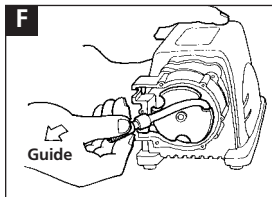
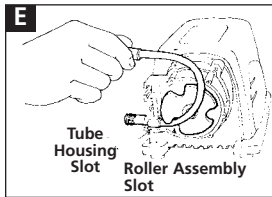

NOTE: Cover Screws are self-tapping and must be backed in to locate original thread before securing. If a screw boss is stripped, use alternate bosses and position opposite from each other. Never secure the cover plate with more than 2 screws.

INSTALL NEW TUBE

1. Press the PRIME button until one of the slots in the roller assembly aligns with the "IN" (suction) tube fitting slot in the housing. Press again to stop.
2. Place tube fitting into suction side slot of the housing and the roller assembly slot.
Illustration E
3. Press the PRIME button to jog the roller assembly while guiding the tube to prevent it from getting pinched between the housing and roller assembly.
IMPORTANT! Avoid rotating wrist, which can result in a twisted tube that will not center. **DO NOT** force tube and be careful of your fingers.
4. Guide tube, with slight tension (toward the center) to prevent pinching between housing and roller assembly. **Illustration F**
5. When the roller assembly slot reaches the housing slot that the fitting inserts into, depress the PRIME button to aid in stretching the tube assembly until it can be inserted into the housing.
NOTE: A used tube will have stretch approximately 3/4" and the new tube will appear to be stiff and short. Follow directions to allow rollers to stretch tube into place.
6. Allow rollers to stretch tube into place while guiding tube into slot. **Illustration G**
7. Press the prime button to turn off.
8. Apply a small amount of grease (AquaShield®) to cover bushing ONLY and replace cover and two screws, leaving front screw in-between the fittings loose.

Tube Replacement continued – center new tube

CENTER NEW TUBE

1. To center the tube on the rollers, press the PRIME button to continually rotate the rollers.
Illustration H
2. Turn the tube fitting on the suction side not more than 1/8 of a turn in the direction tube must move.
3. **DO NOT** let go of fitting until tube rides approximately in center of rollers.
4. Press the PRIME button to turn “Off.” Tighten cover screws. Cover is not on securely if there is a gap between screw boss and cover. **Illustration I**

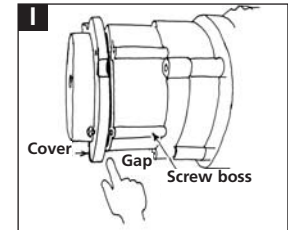
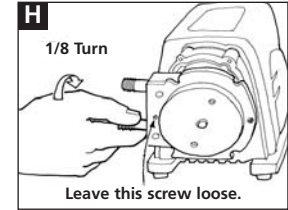

Cleaning the Point of Injection – safety information

! **NOTICE:** Indicates special instructions or general mandatory action.

! **NOTICE:** 0-25 psi models are installed using an injection fitting and 26-100 psi models use an injection check valve. Both allow the extension tip to be installed in the center of the pipe directly in the flow of water to help reduce deposit accumulation.

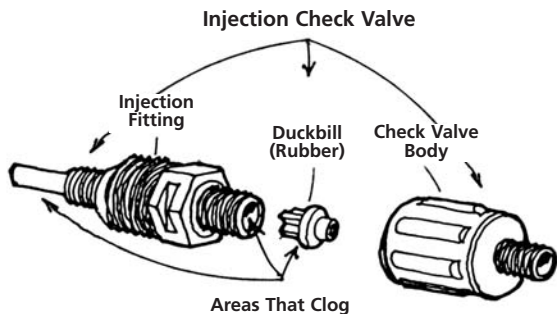

! **⚠️ WARNING** Warns about hazards that CAN cause death, serious personal injury, or property damage if ignored.

! **⚠️** This is the safety alert symbol. When displayed in this manual or on the equipment, look for one of the following signal words alerting you to the potential for personal injury or property damage.

! **⚠️ WARNING** HAZARDOUS PRESSURE/
CHEMICAL EXPOSURE:

- !** Use caution and bleed off all resident system pressure prior to attempting service or installation.
- !** Use caution when disconnecting discharge tubing from pump. Discharge line may be under pressure. Tubing may contain chemical.
- !** To reduce risk of exposure, the use of proper personal protective equipment is mandatory when working on or near chemical metering pumps.

Cleaning the Point of Injection continued

1. Turn metering pump off and unplug cord. Disable water pump or auxiliary equipment electrical supply.
2. Depressurize system and bleed pressure from pump discharge tubing.
3. Loosen and remove connecting nut and ferrule from the injection check valve or injection fitting to disconnect discharge tubing.
4. Insert a #2 Phillips head screwdriver through injection fitting into the pipe to locate or break up accumulated deposits. If screwdriver cannot be inserted, drill the deposit out of the injection fitting (**DO NOT** drill through the opposite pipe wall).

26-100 psi models:

- Unscrew the top fitting (check valve body) to disassemble. The bottom fitting (injection fitting with arrow) should remain attached to the pipe.
- Remove duckbill from check valve body and replace if deteriorated or swollen. If clogged, clean or replace (yearly replacement recommended).
- Examine O-Ring on the injection fitting and replace if deteriorated or damaged.

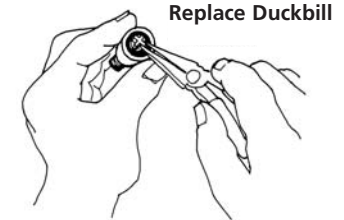

Periodic inspection and cleaning of the point of injection will maintain proper pump operation and provide maximum tube life.

More on next page...

Cleaning the Point of Injection continued

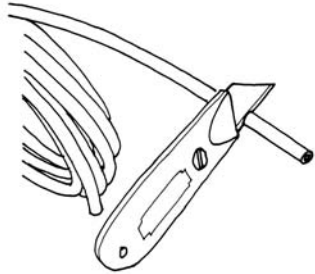

Cut off the calcified or blocked section.

5. Replace discharge tubing if cracked or deteriorated. If the end is clogged, cut off the calcified or blocked section of tubing.

0-25 psi models:

Replace ferrule and insert the discharge tubing into the injection fitting approximately 3/4" - 1" until it stops.

26-100 psi models:

- Reassemble the injection check valve in reverse order.
- Replace ferrule and insert the discharge tubing into the injection check valve approximately 3/4" until it stops.

6. Tighten the connecting nut finger tight.
7. Enable the water pump electrical supply and pressurize the water system.
8. Put the metering pump back in service and inspect all connections for leaks.

Motor – exploded view

Contact factory for part numbers.

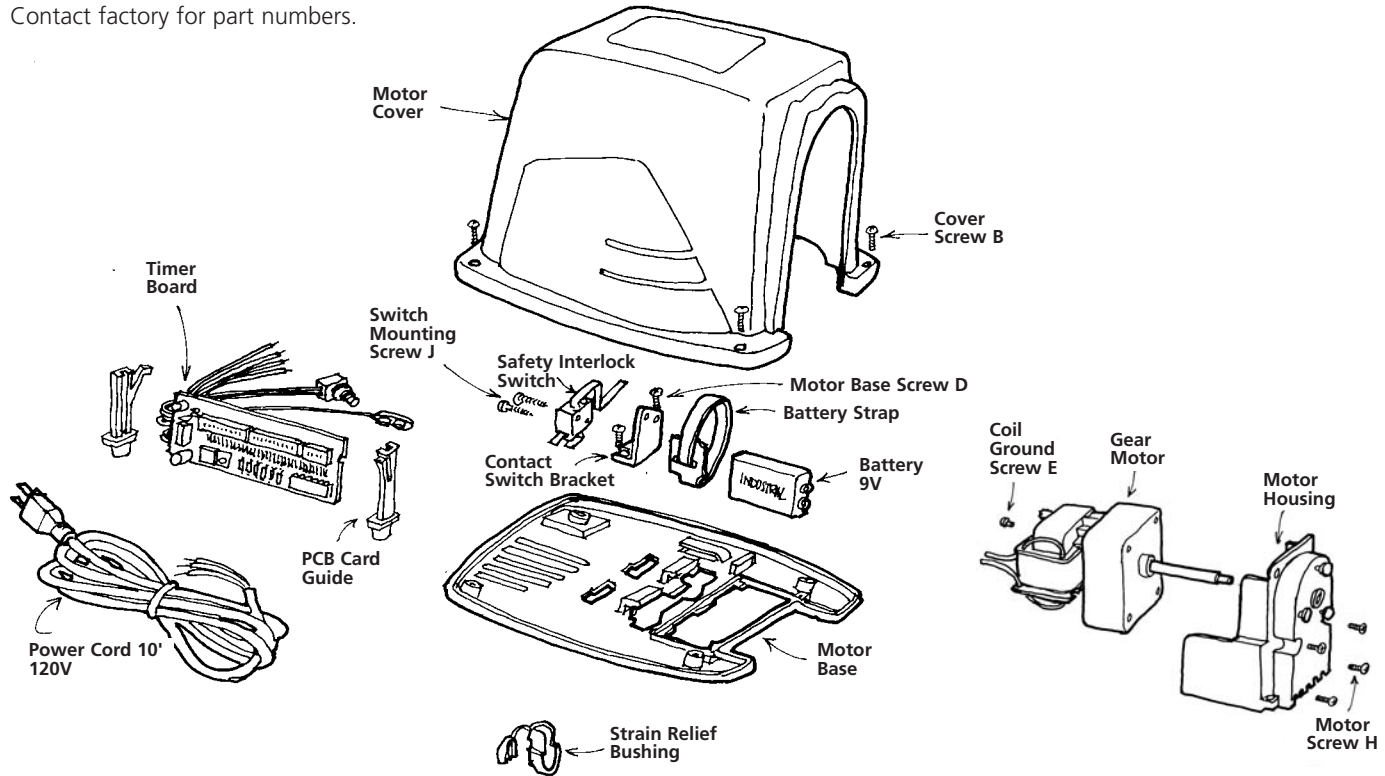

Pump Head – exploded view

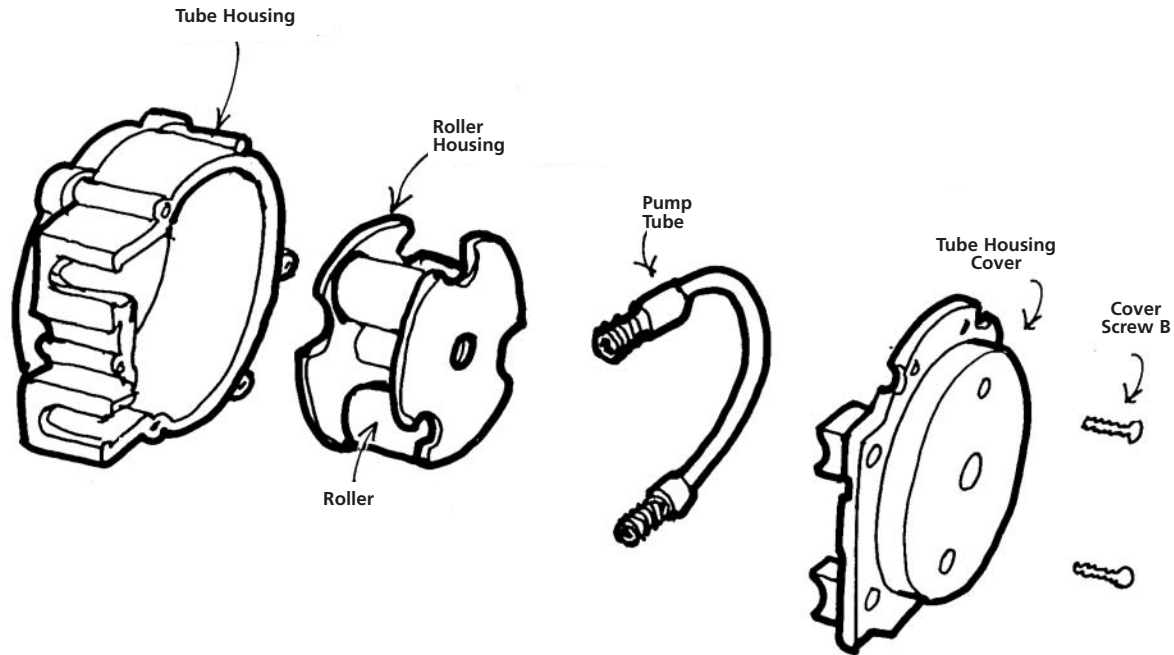

Contact factory for part numbers.

Pump Head continued – service kits

PUMP HEAD SERVICE KITS

DESCRIPTION	PART NUMBER	UM
SANTOPRENE® Kit 0-25 psi (0-1.7 bar)	PSKLO_* * select tube number 1, 2, 3, 4, 5	KIT
SANTOPRENE® Kit 26-100 psi (1.7-6.9 bar)	PSKHO_* * select tube number 1, 2	KIT
TYGOTHANE® Kit 0-25 psi (0-1.7 bar)	PSKLT_* * select tube number 2, 5	KIT
Kit 26-100 psi (1.7-6.9 bar) includes TYGOTHANE® #2 Pump Tube & PELLATHANE® duckbill	PSKHT2	KIT

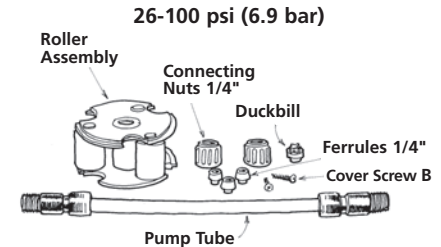
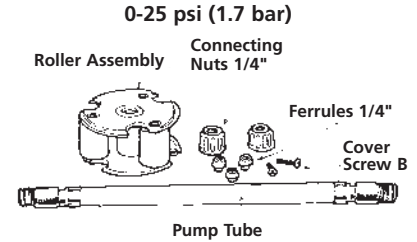

Pump Head continued – subassemblies

Pump Head

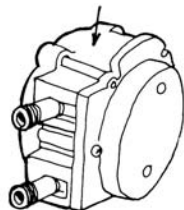

Pump Tube Numbers

#1 and #2 for 26-100 psi pump
(when used with check valve).

#1, 2, 3, 4, 5 for 0-25 psi pump.

PUMP HEADS

DESCRIPTION	PART NUMBER	UM	PART NUMBER	UM
Pump Head includes SANTOPRENE® pump tube, ferrules 1/4"	UCTHC_*_D	EA	MCTHC_*_D	PK of 2
	* select tube number 1, 2, 3, 4, 5			
Pump Head includes SANTOPRENE® pump tube & duckbill, ferrules 1/4"	UCPH_*_FD	EA	n/a	
	* select tube number 1, 2			
Pump Head includes TYGOTHANE® pump tube, ferrules 1/4"	UCPTH0_*	EA	n/a	
	* select tube number 2, 5			
Pump Head includes TYGOTHANE®#2 pump tube, PELLATHANE® duckbill, ferrules 1/4"	UCPHTD2	EA	n/a	

Pump Tubes

PUMP TUBES

DESCRIPTION	PART NUMBER	UM	PART NUMBER	UM
SANTOPRENE® Pump Tube, ferrules 1/4"	UCCP20_*	PK of 2	MCCP20_*	PK of 5
	* select tube number 1, 2, 3, 4, 5			
SANTOPRENE® Pump Tube & Duckbill, ferrules 1/4"	UCCP_* FD	PK of 2	n/a	
	* select tube number 1, 2			
TYGOTHANE® Pump Tube, ferrules 1/4"	UCTYGO_*	PK of 2	MCTYGO_*	PK of 5
	* select tube number 2, 5			
TYGOTHANE® #2 Pump Tube & PELLATHANE® Duckbill, ferrules 1/4"	UCTY2FD	PK of 2	n/a	

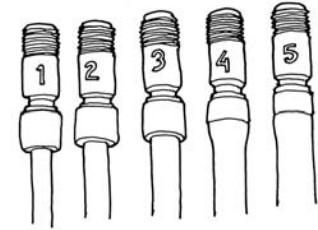

Pump Tube Numbers

#1 and #2 for 26-100 psi pump
(when used with check valve).

#1, 2, 3, 4, 5 for 0-25 psi pump.

Check Valves

Injection Check Valve 1/4"



CHECK VALVES

DESCRIPTION	PART NUMBER	UM	PART NUMBER	UM
Check Valve includes SANTOPRENE® duckbill; ferrules 1/4"	UCDBINJ	EA	MCDBINJ	PK of 5
Check Valve includes PELLATHANE® duckbill; ferrules 1/4"	UCTYINJ	EA	MCTYINJ	PK of 5

For Your Records

Model: _____

Serial Number: _____

Date of Installation: _____



STENNER

Peristaltic Metering Pumps
Since 1957

Stenner Pump Company

**3174 DeSalvo Road
Jacksonville, Florida 32246**

Phone: 904.641.1666

US Toll Free: 800.683.2378

Fax: 904.642.1012

sales@stenner.com

www.stenner.com

Hours of Operation (EST):

Monday 7:00 am–5:00 pm

Tues.–Fri. 7:00 am–5:30 pm

© Stenner Pump Company

All Rights Reserved